



erklären

Der Permanentmagnet-DC-Motor der ZYT-Serie nimmt Ferrit-Permanentmagnetanregung an. Als stromsparender Gleichstrommotor kann er als Antriebselement in verschiedenen Geräten eingesetzt werden.

Kann verschiedene Reduzierer direkt anschließen, wie z.B.:

Schneckengetriebe der Baureihe RV;

Mikrozykloidreduzierer der Serie WB;

B.X Serie Zykloidal Pinwheel Reduzierer und verschiedene andere Reduzierer.

Charakteristik

Motorgehäuse: Die äußere Schale besteht aus Stahl, der nicht leicht zu rosten oder zu korrodieren ist

Verarbeitungstechnik: raffinierte Verarbeitungstechnik, mit glatten Kanten auf der Oberfläche der Eisenschale

Gute Wärmeleitfähigkeit: Ausgezeichnete Wärmeleitfähigkeit, hohe Härte, verringerte Reibung, wodurch der Motor schneller läuft

Motorrotor: Hochpräzise Lagerpassung, glatter Betrieb, hohes Drehmoment und geringe Geräusentwicklung

Installation form:

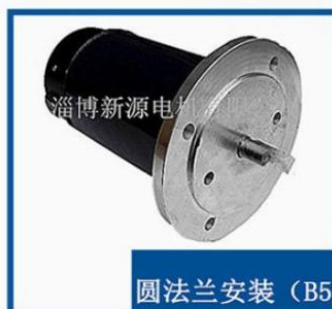
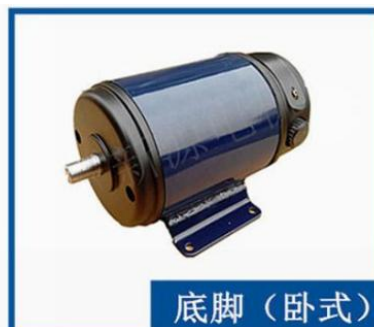
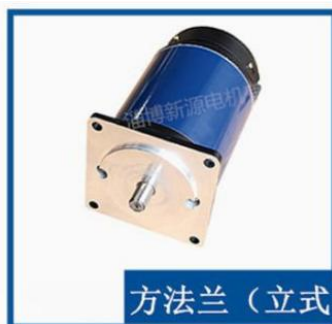

Modell erklären: 55 ist Durchmesser Länge

Model explain: 55 is diameter length

model	torque / ( mN.m ) Drehmoment	Speed ( r/min )	Power ( W ) Leistung	Voltage ( V ) Spannung	current Strom	Allowed speed difference Zulässige Drehzahldifferenz	
55ZYT01	63.7	3000	20	24	1.5	200	
55ZYT02	63.7	3000	20	27	1.3	200	
55ZYT03	63.7	3000	20	48	0.7	200	
55ZYT04	63.7	3000	20	110	0.34	200	
55ZYT05	55.7	6000	35	24	2.5	300	
55ZYT06	55.7	6000	35	27	2.2	300	
55ZYT07	55.7	6000	35	48	1.3	300	
55ZYT08	55.7	6000	35	110	0.54	300	
55ZYT10	63.7	3600	24	110	0.4	200	
55ZYT51	92.3	3000	29	24	2.1	200	
55ZYT52	92.3	3000	29	27	1.8	200	
55ZYT53	92.3	3000	29	48	1.1	200	
55ZYT54	92.3	3000	29	110	0.46	200	
55ZYT55	79.6	6000	50	24	3.45	300	
55ZYT56	79.6	6000	50	27	3.1	300	
55ZYT57	79.6	6000	50	48	1.74	300	
55ZYT58	79.6	6000	50	110	0.74	300	
55ZYT59	85	8000-10000	80	110	1.15	500	
55ZYT61	76.4	5000	40	24	2.5	250	
55ZYT63/H1	127.4	1500	20	24	1.25	100	
55ZYT64/H9	95	3000	30	220	0.25	200	
55ZYT65	89.2	7500	70	110	1.0	400	
55ZYT66	110.8	2500	29	110	0.45	150	
55ZYT68	69.6	5500	40	36	1.7	250	
55ZYT72	95.5	2500	25	24	1.7	150	

Can produce:

Different voltages such as 12V, 36V, 48V, 60V, 110V, etc.

Different speeds such as 1000 rpm, 1500 rpm, 2000 rpm, etc.

Kann produzieren:

Verschiedene Spannungen wie 12V, 36V, 48V, 60V, 110V, usw.

Verschiedene Geschwindigkeiten wie 1000 rpm, 1500 rpm, 2000 rpm, usw..

型号	转矩 (mN.m)	转速 (r/min)	功率 (W)	电压 (V)	电流(A) 不大于	允许顺逆转 速差 (r/min)	附注
70ZYT01	159.2	3000	50	24	3.2	200	
70ZYT02	159.2	3000	50	27	2.9	200	
70ZYT03	159.2	3000	50	48	1.5	200	
70ZYT04	159.2	3000	50	110	0.7	200	
70ZYT05	135.4	6000	85	24	5.2	300	
70ZYT06	135.4	6000	85	27	4.8	300	
70ZYT07	135.4	6000	85	48	2.6	300	
70ZYT08	135.4	6000	85	110	1.1	300	
70ZYT16	191	2000	40	24	2.3	100	
70ZYT21	95.5	3000	50	220	0.2	200	
70ZYT51	223	3000	70	24	4.3	200	
70ZYT52	223	3000	70	27	3.8	200	
70ZYT53	223	3000	70	48	2.2	200	
70ZYT54	223	3000	70	110	0.95	200	
70ZYT55	191.1	6000	120	24	7.5	300	
70ZYT56	191.1	6000	120	27	6.6	300	
70ZYT57	191.1	6000	120	48	3.8	300	
70ZYT58	191.1	6000	120	110	1.6	300	
70ZYT59	166.6	7500-9500	148	110	1.95	400	
70ZYT60	238.8	4000	100	110	1.3	200	
70ZYT80	223	3000	70	80	1.2	200	



型 号	转 矩 (mN·m)	转 速 (r/min)	功 率 (W)	电 压 (V)	电 流(A) 不大于	允许顺逆 转速差 (r/min)	附 注
90ZYT01	323	1500	50	110	0.66	100	
90ZYT02	323	1500	50	220	0.33	100	
90ZYT03	294	3000	92	110	1.2	200	
90ZYT04	294	3000	92	220	0.6	200	
90ZYT05	294	3000	92	24	6.1	200	
90ZYT51	510	1500	80	110	1.1	100	
90ZYT52	510	1500	80	220	0.55	100	
90ZYT53	480	3000	150	110	2.0	200	
90ZYT54	480	3000	150	220	1.0	200	
90ZYT55	510	1500	80	24	5.0	100	
90ZYT56	480	3000	150	24	8	200	
90ZYT101	796	1500	125	110	1.6	100	
90ZYT102	796	1500	125	220	0.8	100	
90ZYT103	733	3000	230	110	2.8	200	
90ZYT104	733	3000	230	220	1.5	200	
90ZYT105	733	3000	230	24	13.5	200	
90ZYT106	796	1500	125	24	6.5	200	
110ZYT51	1177	1500	185	110	2.5	100	
110ZYT52	1177	1500	185	220	1.25	100	
110ZYT53	980	3000	308	110	4.0	200	
110ZYT54	980	3000	308	220	2.0	200	
110ZYT55	980	3000	308	24	16.5	200	
110ZYT56	1177	1500	180	24	8	100	
110ZYT101	1560	1500	245	110	3.0	100	
110ZYT102	1560	1500	245	220	1.5	100	
110ZYT103	1274	3000	400	110	4.8	200	
110ZYT104	1274	3000	400	220	2.4	200	
110ZYT105	1274	3000	400	24	22.5	200	
110ZYT106	1560	1500	250	24	12	100	
110ZYT151	2390	1500	375	110	4.5	100	
110ZYT152	2390	1500	375	220	2.3	100	
110ZYT153	2230	3000	700	110	8.5	200	
110ZYT154	2230	3000	700	220	4.2	200	
110ZYT155	2230	3000	700	24	45.0	200	
110ZYT156	2390	1500	370	24	22	100	

型号	转矩 (mN·m)	转速 (r/min)	功率 (W)	电压 (V)	电流(A) 不大于	允许顺逆 转速差 (r/min)	附注
130ZYT51	3185	1500	550	110	5.8	100	
130ZYT52	3185	1500	550	220	2.9	100	
130ZYT53	3185	3000	1000	110	11	200	
130ZYT54	3185	3000	1000	220	5.5	200	
130ZYT55	3185	3000	1000	24	50	200	
130ZYT56	3185	1500	550	24	28	100	
130ZYT101	3822	1500	700	110	7	100	
130ZYT102	3822	1500	700	220	3.5	100	
130ZYT103	3822	3000	1200	110	13	200	
130ZYT104	3822	3000	1200	220	6.5	200	
130ZYT105	3820	1500	700	24	30	100	
130ZYT106	3820	3000	1100	24	50	200	
130ZYT151	4500	1500	1000	110	8	100	
130ZYT152	4500	1500	1000	220	4	100	
130ZYT153	4500	3000	1500	110	15	200	
130ZYT154	4500	3000	1500	220	8	200	
130ZYT155	4500	1500	1000	24	38	100	
130ZYT156	4500	3000	1200	24	55	200	
130ZYT185	6200	1500	1200	24	60	100	

■底脚卧式安装：A1

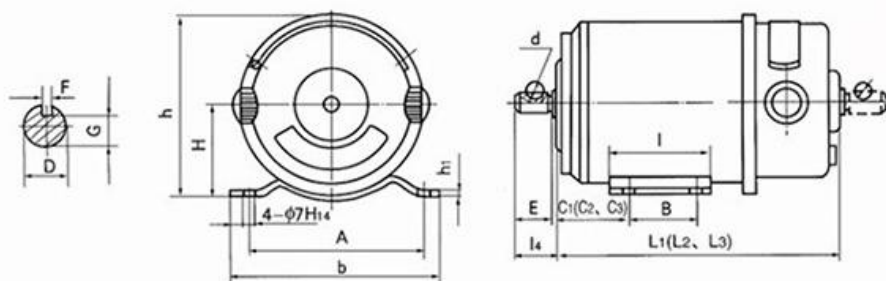

mm

型号	H	h	h <sub>1</sub>	A	b	C <sub>1</sub>	C <sub>2</sub>	C <sub>3</sub>	B	I	L <sub>1</sub>	(L <sub>2</sub> )	(L <sub>3</sub> )	D	E	l <sub>4</sub>	F	G	d	重量 (kg) 不大于
	-	-	-	(±0.25)	-	-	-	-	(±0.25)	-	-	-	-	(h <sub>6</sub> )	-	-	+0.005 -0.015	(h <sub>11</sub> )	(H <sub>11</sub> )	-
70ZYT	42.5	79.5	5	74	90	22	22	22	39	55	114	(124)	(136)	6	12	16	2	4.3	7	2
90ZYT	50 <sub>-0.4</sub>	97.5	3	100	116	32	40.5	49	44	64	127	(147)	(172)	8	16	18	2	5.2	10	4.2
110ZYT	63 <sub>-0.5</sub>	120.5	4	115	130	34	42	57	70	85	172	(188)	(218)	14	20	22	4	11.5	13	8.0

■ 方法兰立式安装：A3

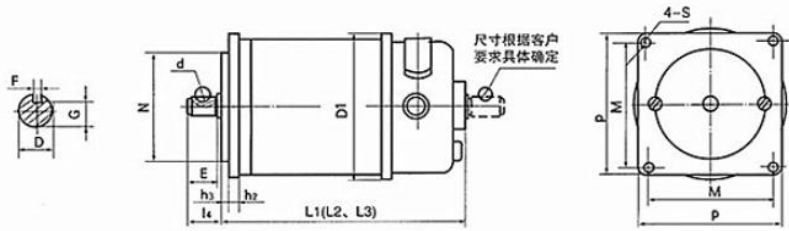

型号	N	h <sub>2</sub>	h <sub>3</sub>	M	P	S	D <sub>1</sub>	L <sub>1</sub>	L <sub>2</sub>	L <sub>3</sub>	D	E	l <sub>k</sub>	F	G	d	重量 (kg) 不大于
	(h <sub>7</sub> )	-	(h <sub>12</sub> )	(±0.15)	-	(H <sub>4</sub> )	-	-	-	-	(h <sub>6</sub> )	-	-		(h <sub>11</sub> )	(h <sub>11</sub> )	
55ZYT	42	4	2.5	48	58	4.5	60	96	106		5	12	13.5	2	3.3	7	0.9
70ZYT	54	5	3	60	72	5.5	74	114	124	136	6	14	16	2	4.3	7	1.6
90ZYT	70	6	3	76	92	6.6	95	127	147	172	8	16	18	2	5.2	10	4.0
110ZYT	85	7	4	94	112	9	115	172	188	218	14	20	22	4	11.5	13	7.8

注：L<sub>1</sub>、L<sub>2</sub>、L<sub>3</sub>代表不同机壳长度的电机。

例如：90ZYT<sub>L1</sub>代表90ZYT01-49，L<sub>2</sub>代表90ZYT51-99，L<sub>3</sub>代表90ZYT101-149。

■ 机壳外圆安装：B14

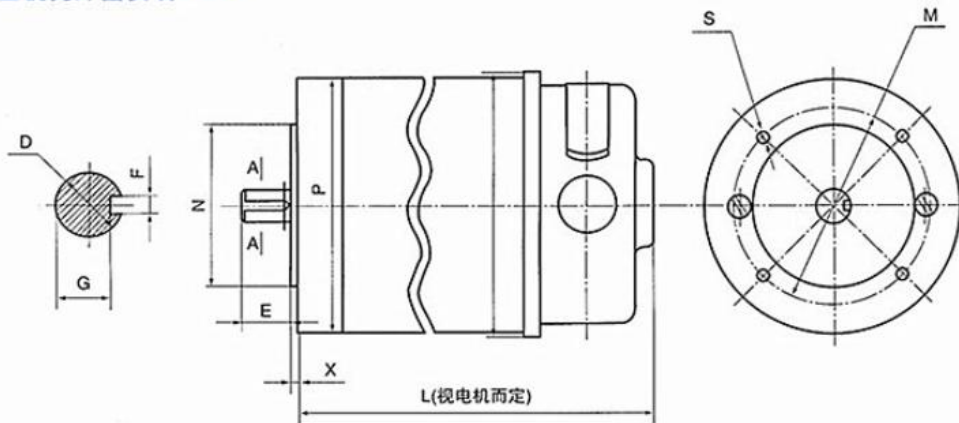

型号	D	E	F	G	M	N	P	S	对应交流电机型号	备注
70ZYT	9	20	3	7.2	55(65)	40(50)	70(80)	M5	Y250B14(56B14)	可直连
90ZYT	11	23	4	8.5	75	60	90	M5	Y263B14	NMRV系列蜗轮蜗杆减速机
110ZYT	14	30	5	11	85	70	110	M5	Y271B14	WB系列微型摆线减速机 X、B系列摆线减速机



■ 方法兰立式安装：A3

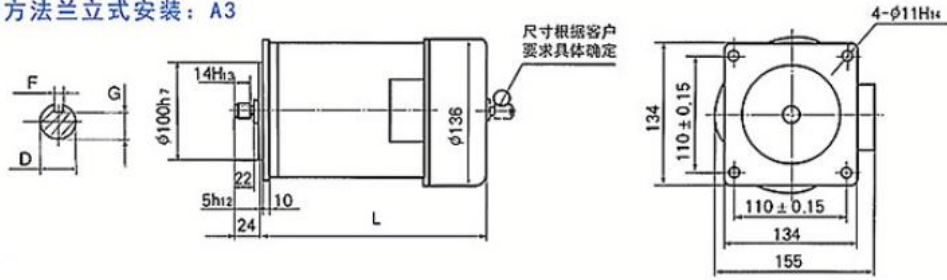

型号	L	D	E	F	G	重量(kg) 不大于
130ZYT51-99	224	14	22	4(5)	11.5	15
130ZYT101-149	244	14	22	4(5)	11.5	17
130ZYT151-159	274	19	40	6	15.5	20

■ 底脚卧式安装：A1

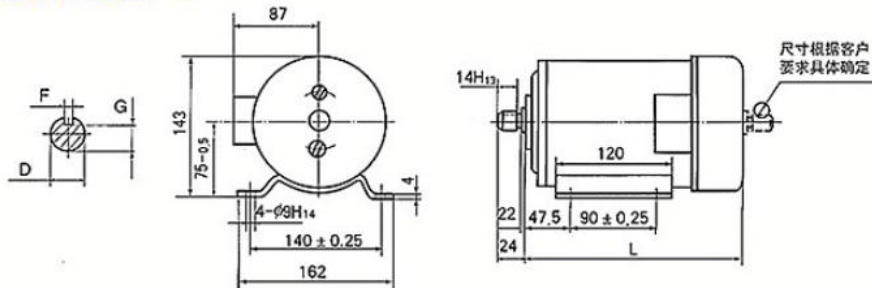

型号	L	D	E	F	G	重量(kg) 不大于
130ZYT51-99	224	14	22	4(5)	11.5	15
130ZYT101-149	244	14	22	4(5)	11.5	17
130ZYT151-159	274	19	40	6	15.5	20

■ 130ZYT系列电机配71B5法兰图

