

220 V DC permanent magnet motor controllable 3600 rpm motor power 500 W reversible variable industrial high-speed motor mute

Description:

Type: DC motor
 Construction: permanent magnet
 Commutation: Brush
 Protection: fully enclosed
 Operating voltage: DC220V
 Output power: 500W
 Dimensions: 110mm * 250MM
 Speed: 3600rpm
 Certification: CCC, CE
 Use: boat, car, household appliance

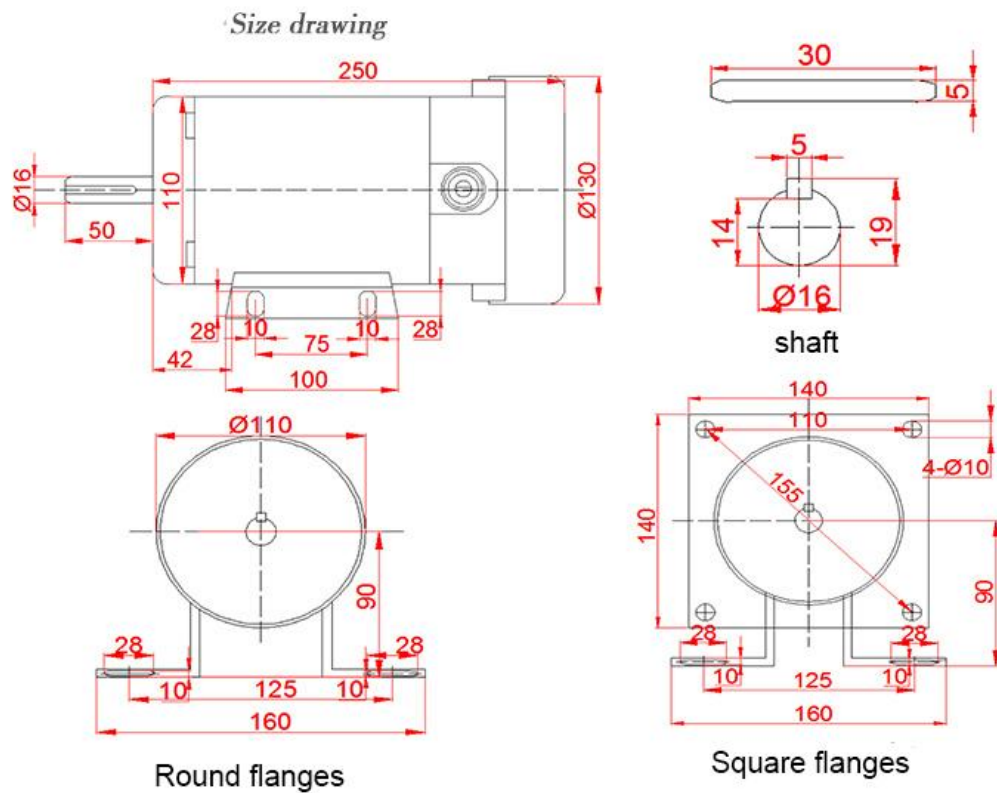

voltage(VDC)	current (AMPS-A)	Speed	power(W)	torque
110	7	1800	500	2.74
220	3.5	1800	500	2.74
220	3.5	3600	500	2.54
220	3.5	4500	500	2.54

Characteristic:

longevity
Low noise
stable
High torque
High speed
Speed regulation

Advantages of products:

armature winding: rotor part adopts pure copper wire coils, the output torque, long service life.
Magnet: the fuselage with two pieces of magnet sector, form a strong magnetic field, the torque, long life
Six fan blades: use six fan blade design, increase heat dissipation, reduce noise and extend the life span.

1 Ankerwicklung

Rotorteil nimmt reines Kupfer
Drahtbund an, Hoch
Ausgangsdrehmoment,
lange Lebensdauer.

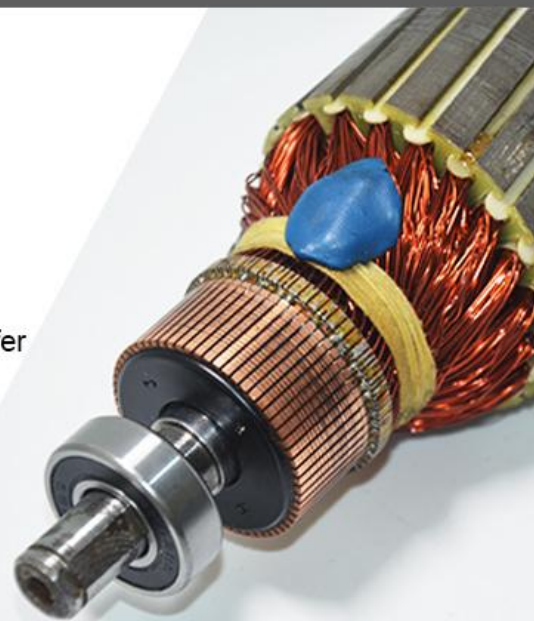

2

starkes Magnetfeld

zwei Magneten von dem Rumpf
wird starkes Magnetfeld bringen,
Hoch Drehmoment, lange Lebensdauer



3 Sechs Lüfterflügel

Verwenden sechs Lüfterflügel-Design, Wärmeableitfähigkeit erhöhen, Lärm reduzieren und das Lebensdauer verlängern.



Uses: small lathes, drilling, conveyor belt, packaging machinery, grinding machine, ceramic Clay molding machine, etc.

Verwendung: kleine Werkzeugmaschinen, Bohren, Fördereinrichtungen, Verpackungsmaschinen, Schleifmaschinen, Schneidemaschinen, Lehmformmaschine usw..

Schleifmaschinen



Lehmformmaschine



Verpackungsmaschinen



Schneidemaschinen



Anschließen



Product Description

The whole machine adopts class B insulation and according to international practice insulation design, thus greatly improve the safety and reliability of the machine.

Motor use the domestic and foreign advanced technology, unique design, with superior quality aluminum alloy die-casting and become!

Unique circular hollow out design, make motor exhaust heat flow, so that the service life of motor longer



Produkte Beschreibung

Die ganze Maschine nimmt Klasse B Isolierung und nach internationaler Praxis Isolierung design, so verbessert es erheblich die Sicherheit und Zuverlässigkeit der Maschine.



Produkte Beschreibung

Die ganze Maschine nimmt Klasse B Isolierung und nach internationaler Praxis Isolierung design, so verbessert es erheblich die Sicherheit und Zuverlässigkeit der Maschine.

Application: Our customer has replaced the original fixed speed motor

